



12.4 GHz TNC FAILSAFE S.P.D.T. SWITCH

OPTIONS: / TTL DRIVE

R F CHARACTERISTICS

FREQUENCY RANGE : 0 - 12.4 GHz
 IMPEDANCE : 50 Ohms

FREQUENCY (GHz)	0 - 1	1 - 2	2 - 3	3 - 8	8 - 12.4
V.S.W.R <=	1.15	1.20	1.25	1.35	1.50
INSERT. LOSS <=	0.15 dB	0.20 dB	0.25 dB	0.35 dB	0.50 dB
ISOLATION >=	85 dB	80 dB	75 dB	70 dB	60 dB
AVER. POWER (*)	350 W	250 W	150 W	120 W	100 W

ELECTRICAL CHARACTERISTICS

ACTUATOR : FAILSAFE
 NOMINAL CURRENT AT 25° C (±10%) : 310 mA
 ACTUATOR VOLTAGE (Vcc) : 12V (10.2 to 13V)
 TERMINALS : solder pins (250 Deg.C max./30 sec)
 TTL INPUTS (E) - High level : 2.2 to 5.5V / 800µA at 5V
 - Low level : 0 to 0.8V / 20µA at 0.8V

MECHANICAL CHARACTERISTICS

CONNECTORS : TNC fem. per MIL C 39012
 LIFE : 1.000.000 cycles
 SWITCHING TIME (nominal voltage;25° C) : < 15 ms
 CONSTRUCTION : splashproof
 WEIGHT : < 185 g

ENVIRONMENTAL CHARACTERISTICS

OPERATING TEMPERATURE RANGE (°C) : -40 , +85
 STORAGE TEMPERATURE RANGE (°C) : -55 , +85

(* : average power at 25° C)

4112-9212 This information is given as an indication. In the continual goal to improve our products, we reserve the right to make any modifications judged necessary

DRAWING

General tolerance: * 0,5 mm

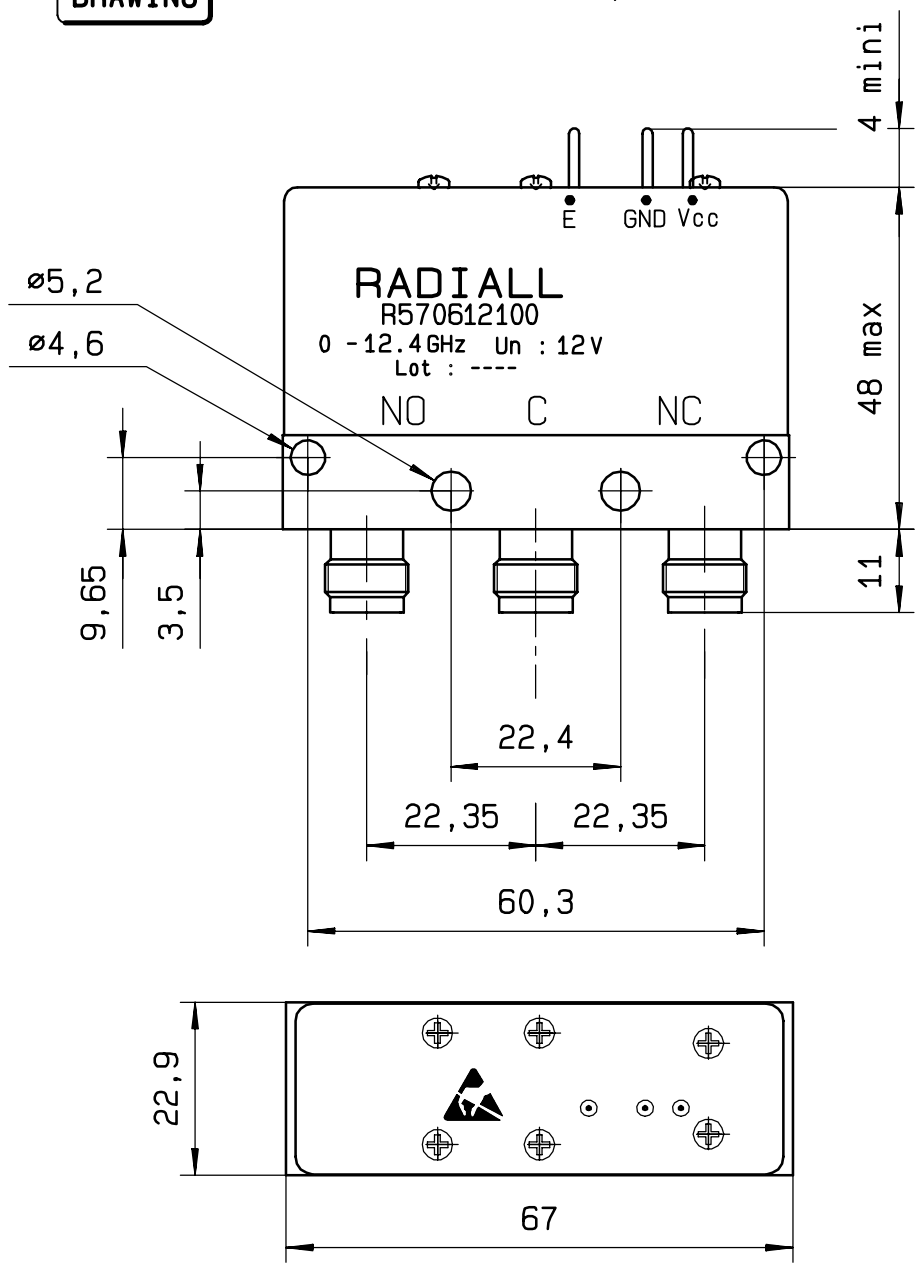

SCHEMATIC DIAGRAM

TTL input	RF continuity
E=0	C ↔ NC
E=1	C ↔ NO

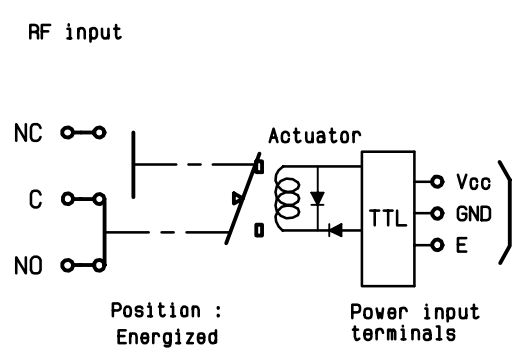

4113-9212 This information is given as an indication. In the continual goal to improve our products, we reserve the right to make any modifications judged necessary